



USER MANUAL

METEO-LCD 14742

Multifunctional Display Unit



Content

1	Introduction	3
2	Functional description	3
3	Performance of the available indicator types	3
4	Step-by-step short instruction	4
5	Mechanical and electrical installation works	4
5.1	Assembly of the indicator housing	4
5.2	Additional technical documents	4
5.3	Electrical connection	5
6	Setting to work of the indicator	5
7	The setup menu	6
7.1	How to use the menu	6
7.2	System Information and entrance to menu	6
7.3	Setup menu „SYSTEM SETUP 1“	6
7.3.1	Brightness and contrast	6
7.3.2	Operation modes	6
7.3.2.1	Wind speed and direction „WIND **“	6
7.3.2.2	Meteorological data „MET“	6
7.3.2.3	Mode „DUAL“ = wind data and meteorological display	7
7.3.2.4	NAV3 mode (change between TRUE/REL/MET)	7
7.3.3	Baud rate	7
7.3.4	Language	7
7.4	Setup menu „SYSTEM SETUP 2“	7
7.4.1	Selection of wind protocol	7
7.4.2	Wind speed unit	7
7.4.3	Mean values	8
7.4.4	Pre-samples	8
7.4.5	View mode „REL“ or „TRUE“	8
8	Interpretation of the readings	8
8.1	Specific performance of the wind display modes with gliding mean values	8
8.2	Toggle mode between true and relative wind display	8
8.3	Display of other parameters	9
9	The indicator in operation	9
9.1	Setting contrast and brightness	9
9.1.1	Operation directly at the indicator	9
9.1.2	External settings	9
9.2	Error messages	9
10	Storage and Maintenance	9
10.1	Storage	9
10.2	Scheduled Maintenance	9
11	Fuse Elements	10
12	Technical data	10
12.1	Electrical and mechanical data	10
12.2	Interface design specification (IDS)	10
13	Support by LAMBRECHT	11
14	Warranty	11
15	Disposal	11

Annex I:		
Design of NMEA 0183 message strings		12



1 Introduction

The digital LAMBRECHT meteo indicators METEO-LCD (14742) are multipurpose indicators which are designed to display the various meteorological and nautical parameters. There are special versions for applications on civil ships (NAV) and for industrial (IND) purposes. The versions -IND and -NAV are also available as versions -IND/ W and -NAV/ W for water resistant panel mounting (front plate design of the LCD in the style of protecting class IP 66).

In order to enable a safe reading under different lightning conditions contrast and brightness can be aligned over a wide range.

Just like many other electronic devices, which are in use for such purposes on ships the standardised data input of the item is carried out in accordance with the NMEA 0183 standard version 2.30. Assumed that all digital input information are available from a talker, the below mentioned modes of operation can be selected with a simple operating menu.

If the indicator was purchased as a component of a complex meteorological measuring system, further operating manuals of other devices as well as general wiring diagrams of the entire system have to be considered.

Before starting installation and connection work on the indicator, we recommend checking the delivery for damage and completeness.

2 Functional description

For the display of information an illuminated transmissive LC-Display with 160 x 128 dots is in use. In order to adapt it to the ambient conditions contrast and brightness can be set by the user.

For the signal input a serial RS 422 interface is provided. All incoming data are expected as digital message strings according to the NMEA 0183 standard which nowadays is world-wide in use.

Once switched on the power supply the display will show "System init... Please wait..." for approx. 15 seconds and afterwards an opening mask containing the firmware version for a short time and then it will move to the final mode of operation as it has been in use before.

All required data have to be transferred to the indicator as standardised serial data strings in a message format according to the NMEA 0183 format e.g. generated by a LAMBRECHT meteo data logger or a similar device. More information can be obtained from the chapters at the end of this document.

The 24 VDC supply voltage and the serial interface RS 422/485 are galvanically isolated.

3 Performance of the available indicator types

In the present document the operation of the model versions METEO-LCD-IND and METEO-LCD-NAV are commonly described. The variations between the three models are mentioned in the table below.

Mode	Parameters	Display	LCD-type
„Rel. Wind“	„rel. WD“ + „rel WS“	quasi-analog & digital	IND, NAV
Dual Mode (manually)	change betw. WIND and MET	quasi-analog & digital	IND, NAV
Meteorology	TA+ r. H.+ PA+ TD	digital	IND, NAV
„True Wind“	„true WD“+ „true WS“	quasi-analog & digital	NAV

<i>WD</i>	<i>Wind direction</i>
<i>WS</i>	<i>Wind speed</i>
<i>r. H.</i>	<i>Rel. humidity</i>
<i>TA</i>	<i>Temperature air</i>
<i>PA</i>	<i>Pressure air</i>
<i>TD</i>	<i>Temperature dew point</i>

Versions	Id No.
METEO-LCD-IND	00.14742.401002
METEO-LCD-IND/ W	00.14742.111002
METEO-LCD-NAV	00.14742.301002
METEO-LCD-NAV/ W	00.14742.011002

W = suited for waterproof console mounting
(front panel design based on protection class IP 66)

4 Step-by-step short instruction

All working steps required for a safe setting to work procedure are mentioned below in a short-form

- Check of completeness of the equipment
- Check of transport damages
- Preparations of the installation sites
- Mounting of accessories (power supply units etc.)
- Termination of the communication cables
- Termination of the power supply cables
- Check of the electrical installation before switching on the power
- Power on pressing the circuit breaker or another switch
- Select the desired mode of operation
- Set the desired brightness and contrast in the set-menu

5 Mechanical and electrical installation works

5.1 Assembly of the indicator housing

The indicators with standard housing of 144 x 144 mm or with 160 x 160 mm (W-versions) are designed for panel mounting. The corresponding panel cutout must have the size of 138 x 138 mm.



In order to obtain mounting impermeability with the versions IND/ W and NAV/ W also, the panel has to be plane, equipped with a waveless surface (e.g. blank metal, smooth lacquer, no hammer effect enamel or the like) and must not mechanically twisted during mounting!

To be fixed properly in a panel the four fixing clamps delivered together with the item have to be mounted to the indicator after it has been inserted into it. Finally the four screws have to be tightened securely evenly and enough fast, so that there is no space between the frame of the indicator and the panel.

Because of the only small amount of heat through the maximum power consumption of 9 VA, there are no particular precautions to be taken when the device is mounted in an exterior housing.

For outdoor applications the specified ambient temperatures of 0...+50 °C has to be considered. Out of this temperature range the typical restrictions of LCDs can appear.

In case the indicator is mounted in a housing the brightness can be adjusted with an external push-button.

5.2 Additional technical documents

In case of the indicator is part of a complex meteorological measuring system the complete interconnection of all components of the system is mentioned in detail in a specific wiring diagram (designated with the letter codes SKF or SWF followed by a running number) and the corresponding block diagram which have been delivered together with other documents.

Before beginning the installation it is recommended to use only valid Lambrecht documents and drawings. Documents with a preliminary status are clearly marked with the designation „preliminary“ or „vorläufig“ printed in bold letters into the document. Such documents should not be used for installation works.

Dimensioned drawing of the versions METEO-LCD-IND/ -NAV

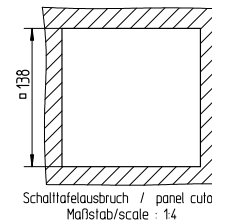
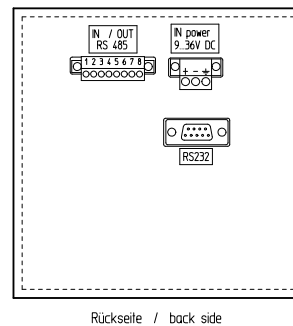
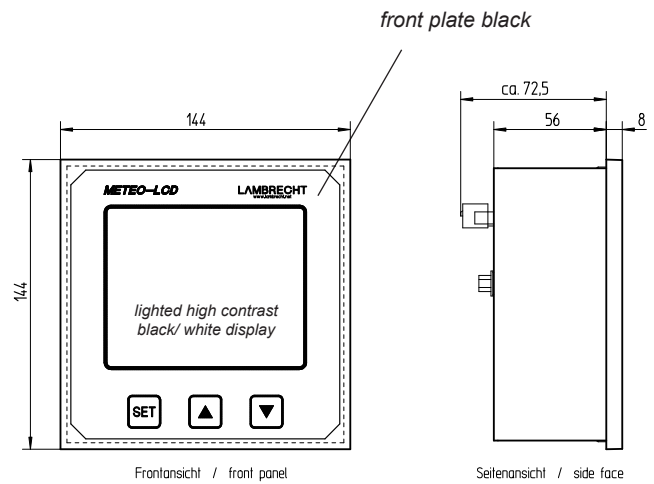

Dimensioned drawing of the waterproof varieties METEO-LCD-IND/ W and -NAV/ W

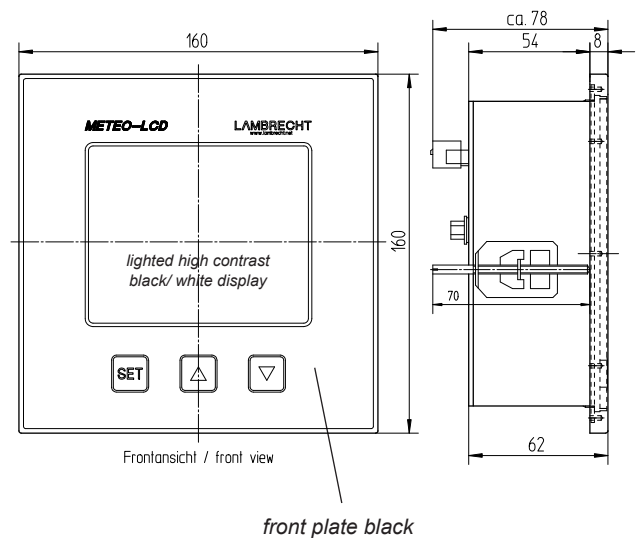

5.3 Electrical connection

All electrical connections to DC power supply (24 VDC = 3 poles) and signal input (RS 422 = 8 poles) are carried out with two separate terminal strips with removable cable plug connector. Due to a different performance of the connectors they can not be mixed up. The connectors are part of the delivery.

For the transmission of digital RS 485 signals double shielded types of cables with twisted pairs of conductors are highly recommended in order to fulfil the EMC/EMI requirements. When terminating the cables it is recommended to use braided, flexible cables and corresponding cable sleeves.

To the „RS 485 IN/OUT“ connector the prepared conductors can be fitted to the spring contacts of the connectors. They can be released by pressing down the orange push-button inside the green plastic socket with a small screw driver. The power supply cables have to be fitted to the connector „IN 24 VDC“ with regular screw terminals. Both sockets have to be fixed with the two screws each in order to secure a safe operation.

As mentioned in the standards of the National Marine Electronics Association (NMEA 0183) it is recommended to connect the inner shields of the signal cables to the signal ground potential on the source (talker) side only.

The common outer shield shall be connected to the back shell (chassis ground) at both ends.

A third connector on the back side designated with „RS 232c“ (9-pole sub-D-connector) is for configuration and service purposes in the factory only. The functions and signals of the connectors are described in the tables below.

IN / OUT RS 485 (8-pole connector)		
PIN No.	Designation	Remarks
1	A IN	RS 485 A-Terminal
2	B IN	RS 485 B-Terminal
3	circuit ground	inner shield
4	A OUT	RS 485 A-Terminal for further indicator
5	B OUT	RS 485 B-Terminal for further indicator
6	circuit ground	inner shield of one wire pair
7	contact	external brightness setting (push button)
8	contact	external brightness setting (push button)
IN 24 VDC (3-pole connector)		
PIN No.	Designation	Remarks
+	9...36 VDC	external DC power supply
-	9...36 VDC	external DC power supply
⊥	GND	Ground

Wire cross section of all pins: 0.14...1.5 mm²

RS 232 (9-pole SUB-D connector)		
PIN No.	Signal	Remarks
1	DCD	External jumper to DTR (4) and DSR (6)
2	RxD	Receive Data
3	TxD	Transmit Data
4	DTR	External jumper to DCD (1) and DSR (6)
5	GND	Signal Ground
6	DSR	External jumper to DCD (1) and DTR (4)
7	RTS	Request to send
8	CTS	Clear to send
9	RI	NC

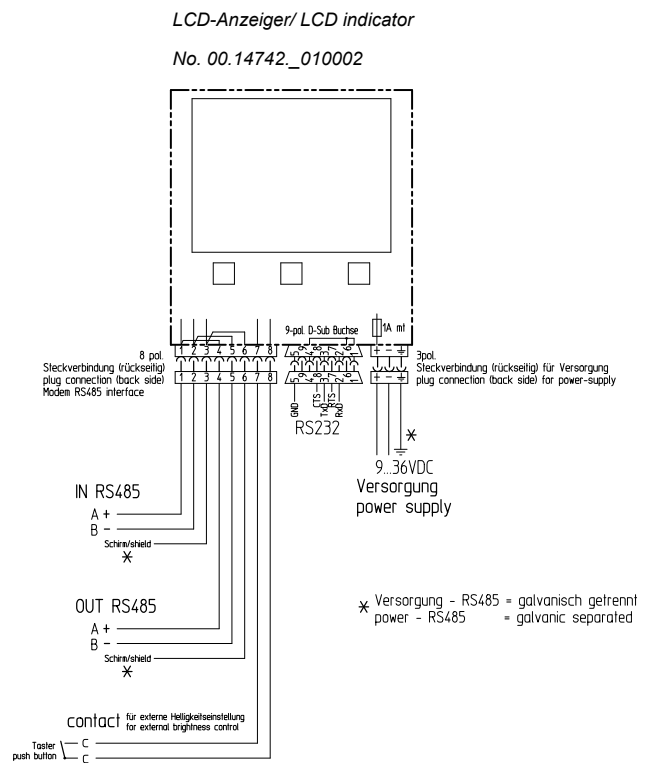

Figure: Electrical connection of the indicator

6 Setting to work of the indicator

After having carried out all mechanical and electrical installation works the system now is ready for the setting to work. Nevertheless in order to prevent damages caused by wrong terminations the whole cabling has to be checked once again before switching on the power by means of an external circuit breaker.

Once switched on the power the system automatically starts to operate as configured before in the factory. When the system is running apart from occasional visual checks no scheduled maintenance is required.

7 The setup menu

The structure of the operating menu is mentioned in the tables below. When leaving the normal display mode i.e. when pressing the SET button the first time a reaction may last up to 2 seconds. Then all responds will appear immediately.

Level 1 Operational mode	Selectable items:
Setup Mode & System Info:  www.lambrecht.net METEO-LCD V 1.30 20.10.2003 EXIT MENUE	EXIT: back to operational mode MENU: to the setup menu

Level 2 Operational mode	Selectable items:
Setup Menu: SYSTEM SETUP 1: BRIGHTNESS: 50 % CONTRAST: 50 % >OPERAT. MODE: WIND * BAUDRATE: 4800 LANGUAGE: ENGLISH EXIT...	0...100 % 0...100 % WIND*/ MET/ DUAL/ NAV3 4800 9600 19200 38400 ENGLISH / DEUTSCH

- For access to the various parameters press SET button.
- An asterisk (*) indicates another present menu in the next level.
- Back to the operational mode: move the cursor to the EXIT position & press the SET button.

Level 3 Operational mode	Selectable items:
Setup Menu: SYSTEM SETUP 2: PROTOCOL*: MWD WIND.S UNIT: KN >MEAN VALUES: 2 MIN PRESAMPLES: 1 VIEW MODE**: TRUE BACK...	MWD / MWV* KN / M/S / MILES 2 MIN / 10 MIN / --- 1 ... 5 TRUE / REL**

- Back to the next higher level: move the cursor to BACK position & press SET button.
- Back to the operational mode: move the cursor to „EXIT“ position & press SET button.
- Remark: In case the dual mode is selected the SET button has to be hold longer than 3 seconds to get access to the menu.

- *) In the „NAV3“ operating mode, the protocol is permanently set to „MWD“.
- ***) In the „NAV3“ operating mode, the display is permanently set to „True“.

7.1 How to use the menu

In the bottom line the buttons are designated to continue the menu or to leave it. Pressing the „MENU“ button a display similar as mentioned in the chapter above -level 2- appears. A cursor „>“ on the left side of the menu-point shows the sub-menu which can be selected now.

When pressing the set-button the cursor moves to the parameter which can be changed now using the „arrow-up“ [▲] and „arrow-down“ [▼] buttons. Pressing the „SET“ button again the cursor returns to the left side of the display.

The asterisk (*) behind the wind mode indicates another menu below. To get back to the next higher level move the cursor to the „BACK...“ position and press the „SET“ button. When moving the cursor to the „EXIT“ position and pressing the „SET“ button indicator returns to the normal display mode.



In case the below mentioned DUAL mode is selected the „SET“ button has to be pressed longer than 3 seconds to get to the described display. More details about this special mode are described in the clauses hereafter.

7.2 System Information and entrance to menu

This display indicates specific data of the integrated firmware version. In case of queries with the indicator this information will help our service department for supporting the user.

7.3 Setup menu „SYSTEM SETUP 1“

7.3.1 Brightness and contrast

As a default setting both parameters are set to 50 % when the indicator gets delivered from the factory. All later settings will be stored internally with a data-hold function (memory) and available again when switching on the indicator again. Details of these settings are described in a following chapter.

7.3.2 Operation modes

In this mode the below mentioned parameters can be indicated depending on the indicator model:

7.3.2.1 Wind speed and direction „WIND **“

The asterisk (*) behind the WIND mode indicates further available parameters to be selected in the next lower level of the menu. When selecting this item the Setup menu „SYSTEM SETUP 2“ appears. Details are described hereafter.

7.3.2.2 Meteorological data „MET“

In this mode the meteorological parameters air temperature, relative humidity, barometric pressure and dew point temperature will be indicated as a digital indicator.

7.3.2.3 Mode „DUAL“ = wind data and meteorological display

In this operating mode it is possible to switch between the two operating modes “WIND” and “METEOROLOGY” with a single press of the SET key. Different from the other operating modes, the DUAL display mode can be left by pressing the SET button for more than 3 seconds.

The change from “WIND” to “MET” is almost instantaneous, while in the opposite direction the change takes a few seconds because the extensive graphics have to be built up.

7.3.2.4 NAV3 mode (change between TRUE/REL/MET)

Prerequisite:

- continuous signal receipt of the wind data telegrams MWV (rel. wind), MWD (true wind) as well as MTA, MHU and MMB for the meteorological display

Basic functions:

- Setting the “NAV3” operating mode in the “SYSTEM SETUP 1” menu:
[Operating mode]-[MET->WIND*->DUAL*->NAV3*]
- In NAV3 mode, the display always starts with “True Wind” and changes cyclically (each time the [SET] key is pressed ([TRUE WIND] -> [Rel. WIND] -> [MET] -> [TRUE WIND] etc.).
- The order and number of screens cannot be changed.
- The sliding average over 2/10 minutes (if selected), is reset each time the display changes and the calculation period is restarted.
- The display of the wind values follows - as in the other operating modes - the selected unit of measurement, i.e. a conversion of the received data takes place if necessary.
- Measured values transmitted by “,” (no valid value or error, depending on the device type) are marked by a dash (minus sign at the outer right position “-”), i.e. the data set was sent without errors, but individual measured values are not available or may be faulty.
- If one or more data sets are not received (timeout), the marking is done as before by “---” (for wind graph) or “----” (for numerical display) for all affected measured values (for numerical display) for all affected measured values.

Changed settings:

- “SYSTEM SETUP 2” (wind, only if “NAV3” operating mode is set):

PROTOCOL:	fixed to MWD (no change possible)
DISPLAY:	fixed to TRUE (no change possible)

- All other menu items can be set as before.

All wind displays in the NAV3 operating mode are based on the above NMEA telegrams. Since it is possible to switch between the 3 display modes during operation, it is not necessary to preselect wind protocol and True/Rel. wind display.

7.3.3 Baud rate

As a default value the baud rate will be set to 4800 as specified in the standards. Apart from this the following transmission rates can be selected on demand:

- 4800
- 9600
- 19200
- 38400

All other remaining interface parameters are fixed and as specified in the NMEA 0183 standard: 8 data bits / no parity / 1 stop bit.

7.3.4 Language

Depending on the country of destination and the application the following languages can be selected:

- ENGLISH
- DEUTSCH

When changing the language the indicator carries out a reset and returns to the meteorological display mode. Therefore this parameter has to be selected first and before selecting other settings.

7.4 Setup menu „SYSTEM SETUP 2“

7.4.1 Selection of wind protocol

In this mode the user can select a NMEA 0183 protocol for indication:

- MWD: true and relative wind
- MWV: relative wind only

For additional information regarding the selection of the wind protocol please refer also to the available view modes as described hereafter.

7.4.2 Wind speed unit

In general the metric values of the wind speed in meters per second (m/s) to be indicated will be obtained from the incoming message strings only. When the mode is set to knots (kn) the conversion will be carried out by the firmware of the indicator based on the metric values.

7.4.3 Mean values

All calculations of the gliding mean values and extreme values are carried out in the indicator based on the received instantaneous data. The following parameters can be selected in the menu:

- 10 minutes
- 2 minutes
- none (--- / off)

The finally selected value of the integration time will be indicated in a field of the normal display mode.

7.4.4 Pre-samples

In some cases the wind indication may be discontinuous due to turbulent conditions. To obtain a certain damping behavior of the display a pre-sampling filter can be activated. This figure in expressed in seconds defines the amount of measuring values to be integrated to a gliding mean value.

For the update of the display contents the same pre-sampling interval as selected above is in process.

Example: when an interval of 3 seconds is selected changes will be indicated every 3 seconds as well.

7.4.5 View mode „REL“ or „TRUE“

This mode allows a selection how to display the wind direction indicator (wind rose) for the NAV and for the IND version of the indicator:

- TRUE: N - NO - O - SO - S - SW - W - NW - N
- REL: 0° - 45° - STB - 135° - 180° - 135° - PTB - 45° - 0°

The finally selected mode of display will be indicated in a field of the operational mode.

8 Interpretation of the readings

8.1 Specific performance of the wind display modes with gliding mean values

When the calculation of mean values is selected in the operation menus before instantaneous and momentary values are indicated together in one display. The illustration mentioned here shall describe the relationship between the different display contents and their meanings.

In case of the calculation of gliding mean WIND values is switched off (setting: ---) both parameters will be displayed as follows:

Wind speed:

Bargraph for tendencies and bold digital characters (7-segment display)

Wind direction:

Analogue wind rose with a ball-pointer and bold digital characters (7-segment display)

The performance of the display design of the other parameters is self-explanatory and does not require any further information.



Wind direction

- (1) numeric maximum of gliding mean value
- (2) graphic extremums of gliding mean value
- (3) analogue instantaneous value
- (4) numeric gliding mean value
- (5) numeric minimum of gliding mean value

Wind speed

- (6) numeric gliding mean value
- (7) analogue instantaneous value
- (8) graphic extremes of gliding mean value
- (9) numeric extremes of gliding mean value

8.2 Toggle mode between true and relative wind display

In case of both message strings for „True wind“ and relative wind are available the indicator easily can be toggled between both modes changing two parameters in the setup menu „SYSTEM SETUP 2“ which is located in level No. 3 of the menu structure.

„True wind“ mode: protocol „MWD“ & view mode „TRUE“

„Relative wind“ mode: protocol „MWV“ & view mode „REL“

8.3 Air pressure trend display

The air pressure trend is indicated by arrow symbols (below the „PRESSURE“ label) as follows:

rising	▲
falling	▼
constant	▲▼



- The calculation is based on a 2 minute average (to suppress fluctuations due to location).
- This mean value is written continuously (every 2 minutes) to a sliding ring buffer.
- The size of the ring memory is 90 measured values for recording the pressure curve within the last 3 hours.
- A change in the 2 minutes mean value by more than ± 0.3 hPa in relation to the moving mean value of the last 3 hours is displayed as „rising“, „falling“ or „constant“ (within ± 0.3 hPa).

8.3 Display of other parameters

The reading and interpretation of the remaining display modes is self-explanatory and shown in the specimen pictures below.

Meteorological parameters:

- Air temperature*
- Relative humidity*
- Dew point temperature*
- Pressure (barometer)*

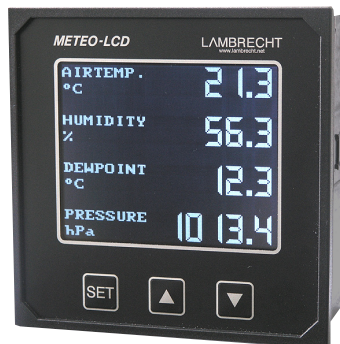

9 The indicator in operation

Once started and configured the item the pre-adjusted setting-conditions are stored in a non-versatile memory which will be hold also when the item is switched off. Therefore the indicator starts working with the recent alignments after it is supplied with DC power again. 10.1 Setting contrast and brightness

9.1 Setting contrast and brightness

9.1.1 Operation directly at the indicator

In the normal mode of operation the indicator shows the measuring values of the connected sensors. When pressing the SET-button in a sequence the menus for “brightness” and “contrast” will be accessible. The selected name of the parameter and a numeric value between 0 and 100 % will be indicated. In this mode of operation also the firmware version is accessible. Desired conditions for the parameters can be selected pressing the “arrow-up” [▲] and “arrow-down” [▼] buttons until they are reached. Brightness and contrast either can be changed

in single steps pressing the button or continuously when the button is pressed and hold down longer than two seconds.

The setting of brightness and contrast are carried out in small steps which allows a fine-tuning (vernier) of the parameters. Therefore the changes may be optically detectable after a time span of a few seconds.

Pressing the SET-button again enables access to the next mode (brightness respectively contrast).

The set mode finally can be left pressing the SET button again in order to return to the normal operational conditions.

When pressing the arrow-buttons [▲] / [▼] in the regular mode the brightness can be aligned.

9.1.2 External settings

If the buttons at the front plate of indicator are no more accessible, the brightness can be adjusted via an external push button which has to be connected to the pins No. 7 and 8 of the „RS 485 IN/OUT“ connector.

In this mode the brightness setting is working in a „saw-tooth“ function. After reaching the maximum (100 %) the indicator starts with the lowest value (0 %) again.

9.2 Error messages

During operation of the item the occurrence of two different error indications will be possible.

In case of missing data the value will be displayed with the characters „ - - - - „, after a time-out of 4 seconds.

Apart from identifiers and data the NMEA strings also are containing a checksum field. When the indicator is on and receiving data the firmware continuously is carrying out a verification. In case of the occurrence of checksum errors instead of numeric figures the display will be „ „.

10 Storage and Maintenance

10.1 Storage

For storage of the indicator METEO-LCD dry and dust-free indoor conditions are required. The storage temperature should be in a range between -20 and +60 °C. During storage the item should be packed in the original card box or a similar packing.

10.2 Scheduled Maintenance

The indicator is designed for a long-lasting period of operation and maintenance-free and does not require any scheduled maintenance. Nevertheless some visual checks have to be carried out from time to time in to detect damages or defects.

If damages are recognizable at the foil of the W-versions, the density is not warranted. In this case the foil and the frame have to be replaced.

In case of the face of the item has to be cleaned only soft and slight wet clothes have to be used. The use of any purifiers has to be omitted in order to prevent damages of the window pane.

11 Fuse Elements

A socket for a G-fuse (1.0 Ampere) of the size 5 x 20 mm is located on the back side of the indicator. It can be opened using a medium seize screw driver of approximately 5 mm. When replacing the fuse a type with similar value urgently has to be used. Any repair of the fuse is not allowed.

12 Technical data

12.1 Electrical and mechanical data

Display:	LCD type: transmissive; high-contrast; black & white; with background illumination
Resolution:	160 x 128 dots
Dot size:	0.54 x 0.54 mm
Dot distance:	0.58 x 0.58 mm
Visible display space:	101 x 82 mm
Galvanic separation:	DC power supply to the serial port RS 485
Power supply:	9 ...36 VDC (24 VDC)
Power consumption:	2.5...5 W
Outer dimensions:	144 x 144 x 72 mm = standard 160 x 160 x 78 mm = W-versions*
Panel cutout:	138 x 138 mm
Required depths:	approx. 125 mm with connectors and cables
Weight:	approx. 0.8 kg
Type of protection:	IP 23 according to DIN 40 050 (front plate design of W-versions* in the style of IP 66)
Range of application:	Operation temp.: 0...+50 °C Storage temp: -20...+60 °C
Relative humidity:	95 % r. h.; no condensation
Standards	Low voltage guideline 72/23/EWG Standard of construction VDE 0100 EMC guidelines: DIN EN 50081/ 82; DIN EN 60945 <u>For NAV versions added:</u> EMC guidelines VG 95373; IEC 61000-4-3 /4-6 Shock resistance BV 0430, diagram 3 Shock Class A ESD / Burst IEC 61000-4-2/ 4-4 Vibration BV 0440, diagram 1, 8, 9

* W-versions = water resistant

12.2 Interface design specification (IDS)

For the display of the meteorological parameters the NMEA 0183 message strings as mentioned below are required by the indicator. From the received message string containing the a.m. parameters the indicator electronic filters, converts and displays the required information. Regarding the sequence of the messages in a common string there is no explicit requirement. As the indicator is evaluating the three-letter-code with sentence formatters only the performance of the talker identifier is not considered.

Air pressure/ barometer:	\$ - - MMB
Air temperature:	\$ - - MTA
Humidity (rel. & abs.):	\$ - - MHU - remark: this information also includes the dew point temp.
Wind (relative):	\$ - - MWV
Wind (true)	\$ - - MWD
Data interface:	RS 422 / RS 485
Message format:	NMEA 0183
Baud rate:	4800 = standard (furthermore available 9600, 19200, 38400)
Frame format:	8 N 1
Sequence of messages:	arbitrary

13 Support by LAMBRECHT meteo

If problems occur during the start-up of your system or later after a period of operation please contact our service department for further support. Please send us an e-mail with a short error description and a copy of the current configuration settings together with the following device data:

- 13-digits LAMBRECHT meteo type number
- System Information (Level 1 of setup menu)
- Reference number of the wiring diagram
- Serial number of the item
- Service and repair

In case of problems and queries which can not be solved at the site we recommend to return the indicator to the address mentioned hereafter:

LAMBRECHT meteo GmbH
Service
Friedlaender Weg 65 – 67
37085 Goettingen
Germany

Tel: +49-(0)551-49 58-0
E-Mail: support@lambrecht.net

A short note describing the defects and/or problems would be highly appreciated by our service engineers in order to localise the source or error.

Remark:

LAMBRECHT reserves the right to change parts of the quoted items/systems to replacements of same quality and performance caused by changes of development and/or production.

14 Warranty

Please note the loss of warranty and non-liability by unauthorized manipulation of the system. You need a written permission of LAMBRECHT meteo GmbH for changes of system components. These activities must be operated by a qualified technician.

The warranty does not cover:

1. Mechanical damages caused by external impacts (e. g. icefall, rockfall, vandalism).
2. Impacts or damages caused by over-voltages or electromagnetic fields which are beyond the standards and specifications in the technical data.
3. Damages caused by improper handling, e. g. by wrong tools, incorrect installation, incorrect electrical installation (false polarity) etc.
4. Damages which are caused by using the device beyond the specified operation conditions.

15 Disposal

LAMBRECHT meteo GmbH is listed and registered at the Stiftung Elektro-Altgeräte Register ear under:

WEEE-Reg.-No. DE 45445814

In the category of monitoring and control instruments, device type: "Monitoring and control instruments for exclusively commercial use".

Within the EU



The device has to be disposed according to the European Directives 2002/96/EC and 2003/108/EC (Waste Electrical and Electronic Equipment). Do not dispose the old device in the household waste! For an environmentally friendly recycling and disposal of your old device, contact a certified disposal company for electronic waste.

Outside the EU

Please follow the regulations in your country regarding the appropriate disposal of waste electronic equipment.

Annex I: Design of NMEA 0183 message strings

\$WIMWD - Wind direction and speed

\$WIMWD,x.x,T,x.x,M,x.x,N,x.x,M,*hh<CR><LF>

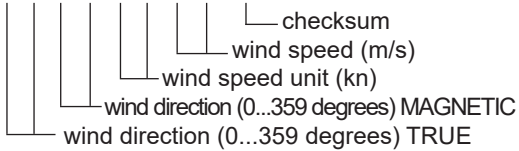

Example:
\$WIMWD,248.7,T,999.9,M,045.0,N,23.1,M*62<CR><LF>

\$WIMWV - Wind speed and angle

\$WIMWV,x.x,a,x.x,a,A,*hh<CR><LF>

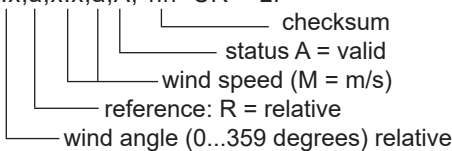

Example:
\$WIMWV,248.7,R,23.1,M,A,19*<CR><LF>

\$WIMTA - Air temperature

\$WIMTA,x.x,C*hh<CR><LF>

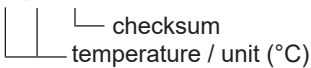

Example:
\$WIMTA,023.75,C*28<CR><LF>

\$WIMMB - Barometric pressure

\$WIMMB,x.x,I,x.x,B*hh<CR><LF>

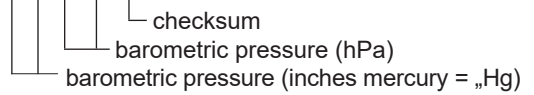

Example:
\$WIMMB,29.17,I,0987.9,B*65<CR><LF>

\$WIMHU - Humidity

\$WIMHU,x.x,x.x,x.x,C*hh<CR><LF>

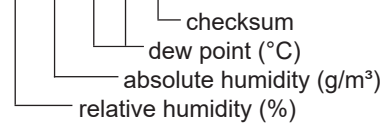

Example:
\$WIMHU,039.8,021.4,009.2,C*2D<CR><LF>

\$HEOSD - Own ship data

\$HEOSD,x.x,A,x.x,a,x.x,a,x.x,x.x,a*hh<CR><LF>

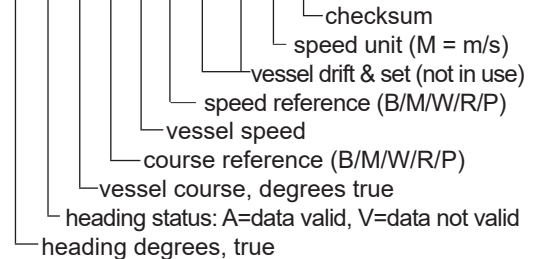

Example:
\$HEOSD,90.0,A,90.0,P,15.0,P,.,.,0,N,*40<CR><LF>

Roll and pitch angles -

PLATH proprietary sentence \$PPPRP

\$PPPRP,x.x,x.x*hh<CR><LF>

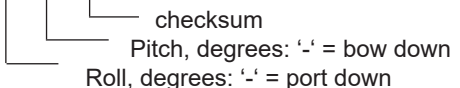

Example:
\$PPPRP,+00.10,-02.00*57<CR><LF>